

Fig 5-1

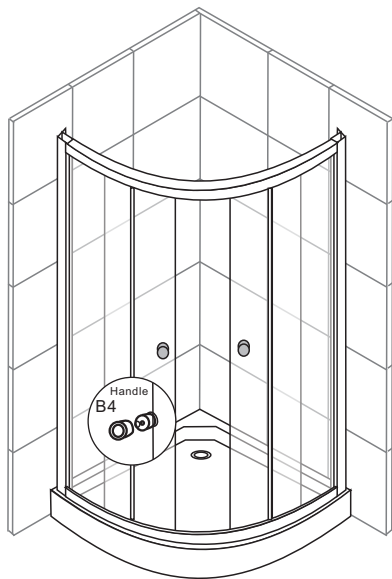
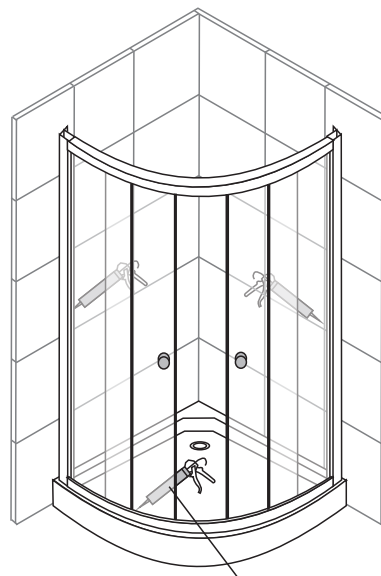
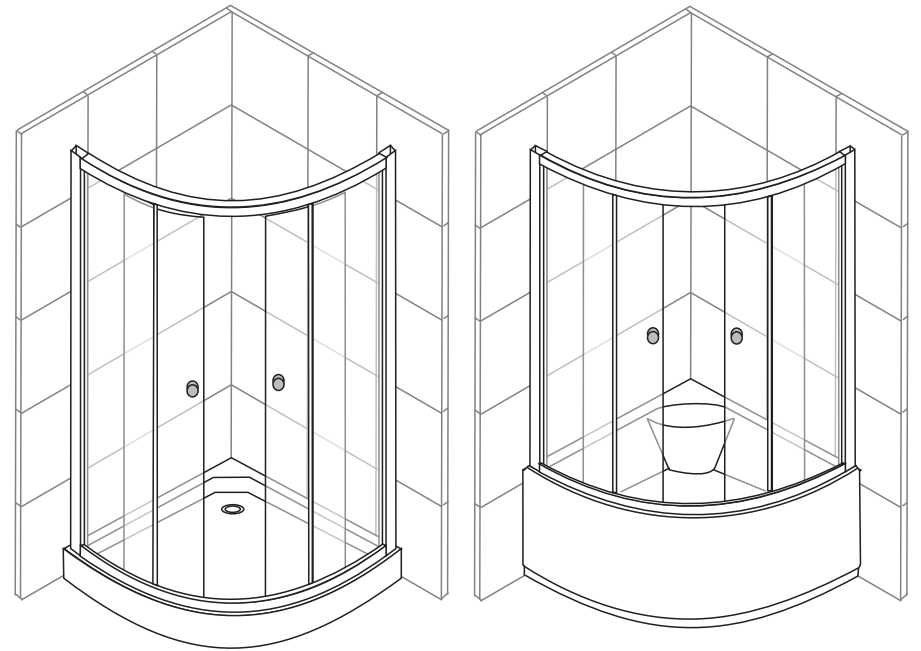

Fig 5-2



SILICON
Fig 6

INSTALLATION MANUAL



Please read installation manual carefully before installation

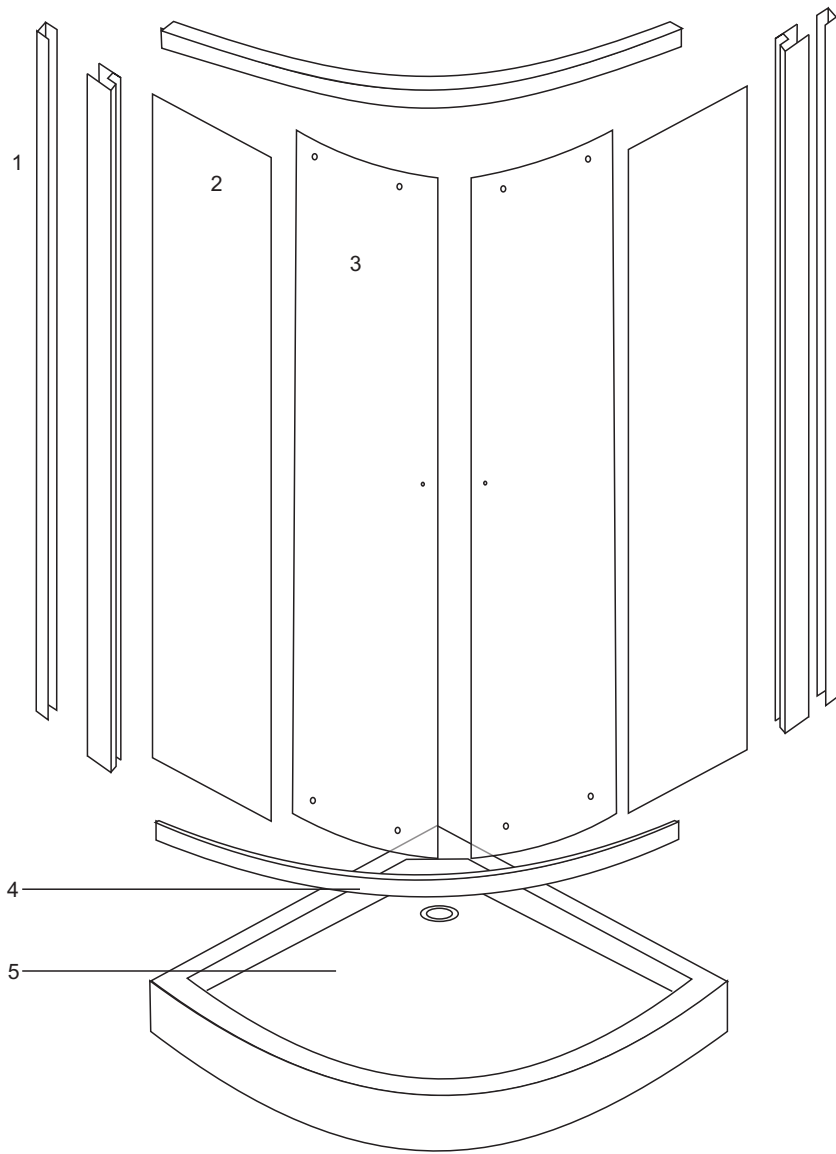

- 1.aluminum profile adjustable profile
- 2.fixed glass door
- 3.sliding door
- 4.arched Alum profile
- 5.base tray

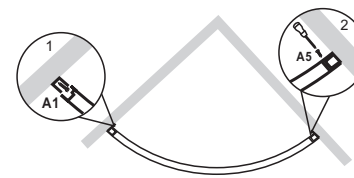
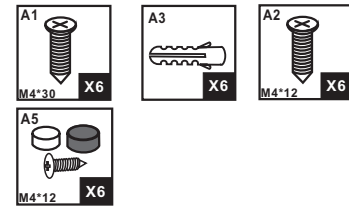
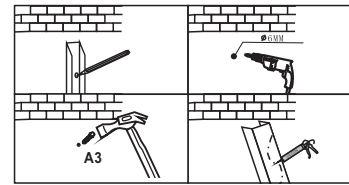

Fig 3-1

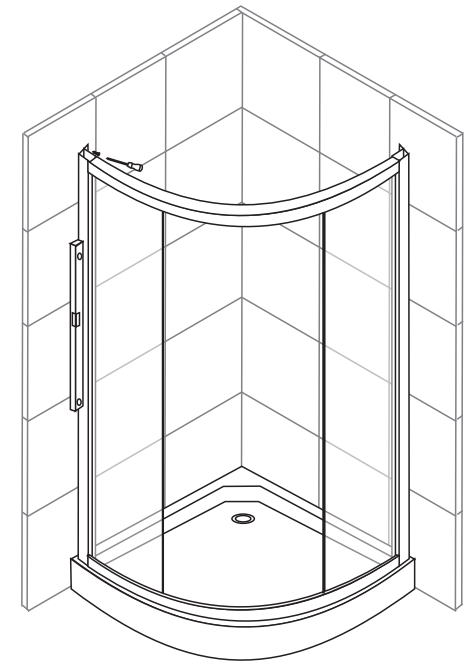

Fig 3-2

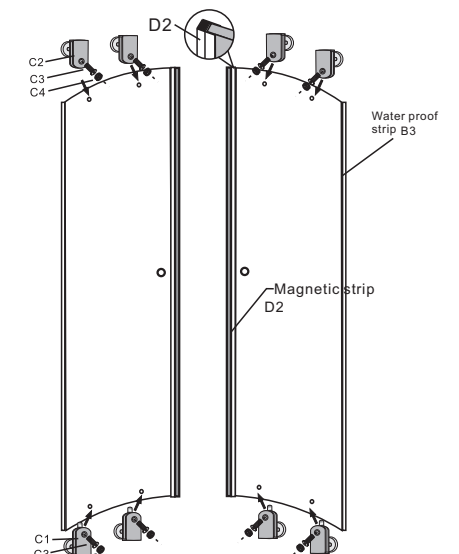
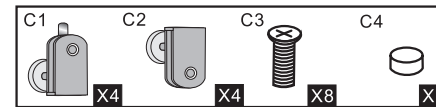

Fig 4

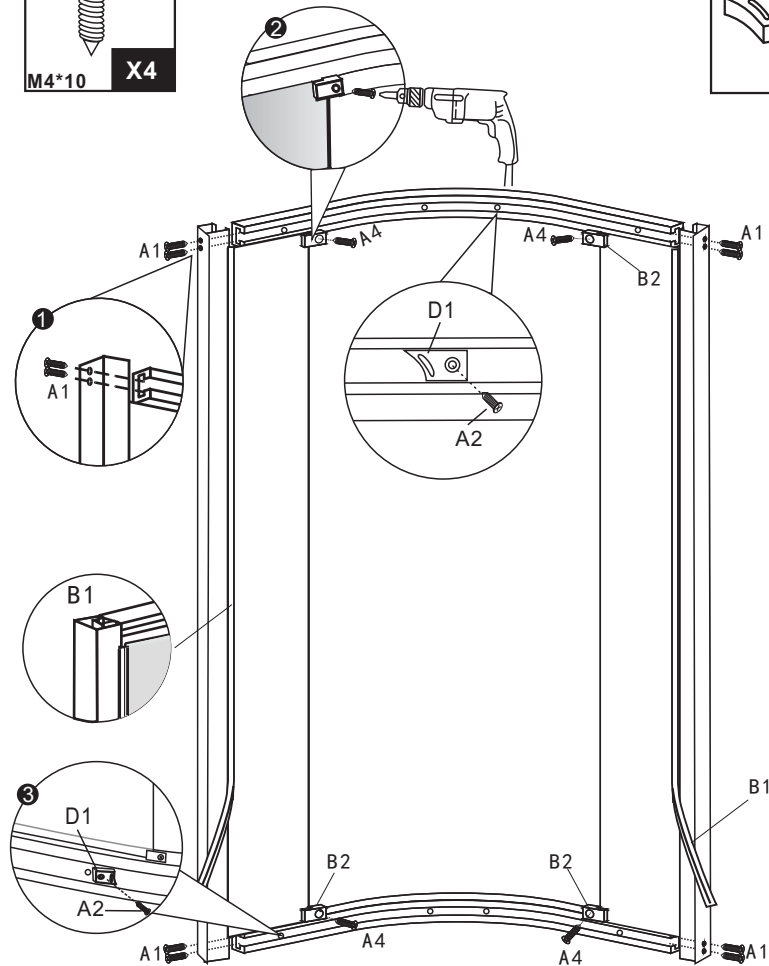
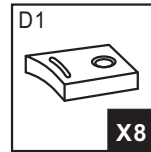
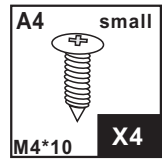
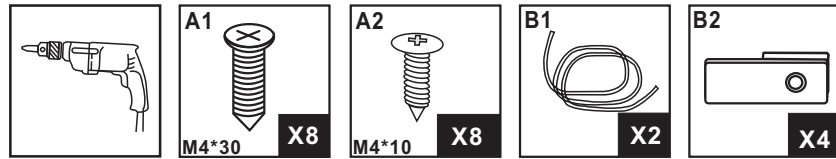
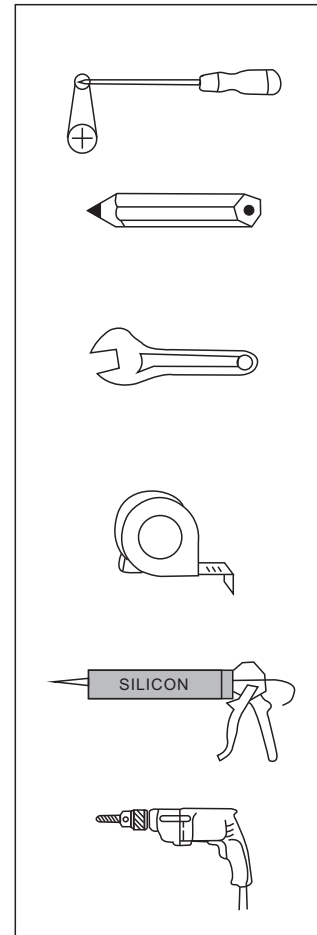



















Fig 2



A1	 M4*30	14pcs
A2	 M4*10	8pcs
A3		6pcs
A4	small  M4*10	4pcs
A5	   M4*12	6pcs
B1		2pcs
B2		4pcs
B3		4pcs
B4		2pcs
C1		4pcs
C2		4pcs
C3		8pcs
C4		8pcs
D1		8pcs
D2		2pcs

Assemble steps

1. Pull the base tray into wall corner, rotate adjusting part of plastic feet to secure the balance of tray and the smooth of drainer (fig 1).
2. Fix the frame:
 - <1> Connect the arched Alum profile and Alum frame with screw **A1**
 - <2> Put the protect strip **B1** to one side of fixed glass door, and install the fixed glass door inside the Alum frame; then fix up the glass with glass clamps **B2** with screw **A2**.
 - <3> Install the glass stop **D1** on the arched Alum profile with screw **A4** (fig 2)
3. Use a level adjust the wall Alum frame upright, then drill three hole on the wall according to the holes on the wall Alum frame (fig 3-1). Fix the two sides wall Alum profile against the wall with screw **A1** (fig 3-2).
4. Install 8pcs of wheels onto the sliding door, fix the magnetic strip **D2** to the sliding door (fig 4).
5. Put the sliding glass doors to the shower frame. Adjust the wheels to keep the the balance and upright of shower unit. install the handle to the glass door (fig 5-1 fig5-2 fig5-3).
6. Apply silicone sealant along the wall profiles and bottom guide rail (fig 6).

Product Maintenance

1. Tempered glass can be clean with nonabrasive bathroom cleaner or any glass cleaner you use elsewhere in your home. Rinse off any glass cleaner that gets on the aluminum as possible to avoid damage to the anodized surface. Avoid striking it with any sharp or hard objects. Such damage can cause either immediate or delayed breakage of tempered glass.
2. The aluminum in your shower door is durable and resistant to water damage. It is advisable, but not necessary to wipe it with your towel after your shower. Clean it as often as needed to keep the buildup off. Never use any type of abrasive cleaner. Use only a soft damp cloth and nonabrasive bathroom cleaners.

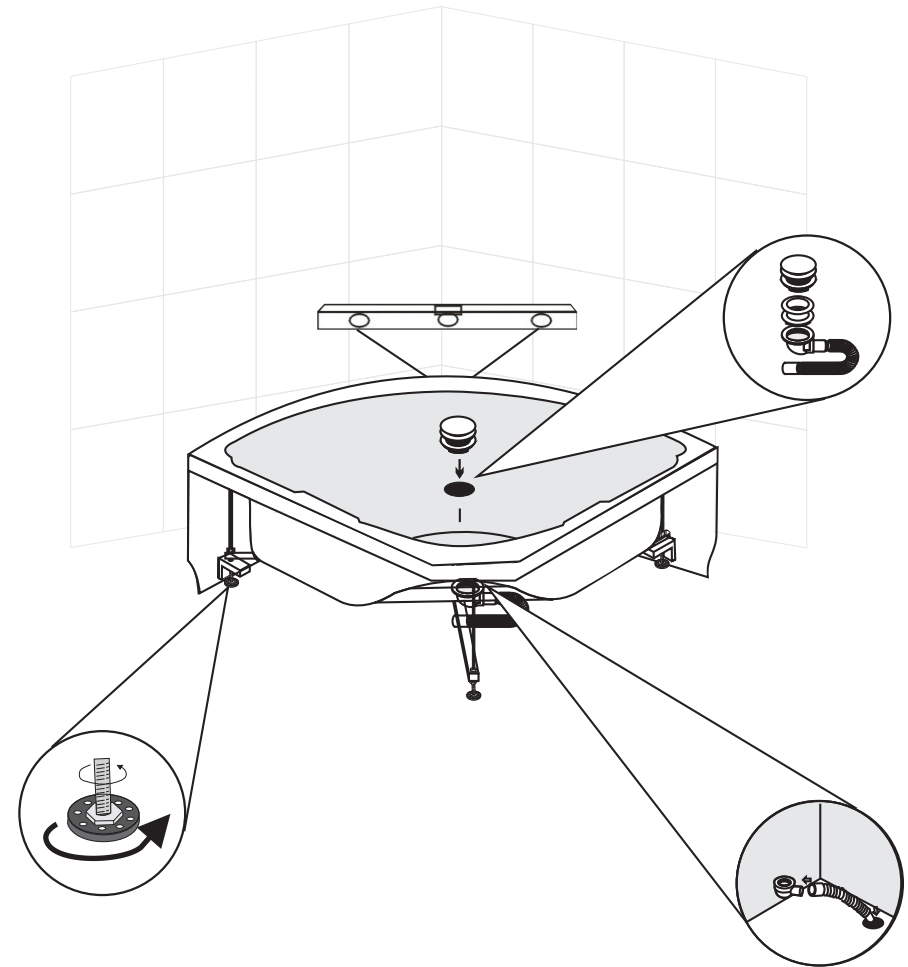
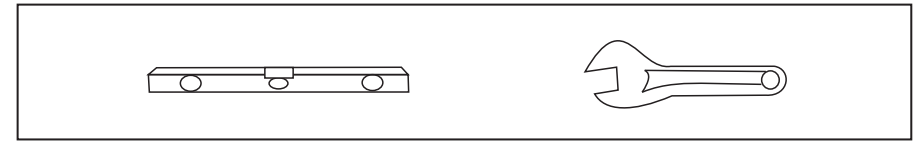

Fig 1